

GSM/GPRS/GPS Vehicle Tracker

Model A/B User Manual



Preface

Thank you for purchasing the tracker. This manual shows how to operate the device smoothly and correctly. Make sure to read this manual carefully before using this product. Please note that specification and information are subject to changes without prior notice in this manual.

Any change will be integrated in the latest release. The manufacturer assumes no responsibility for any errors or omissions in this document.

Contents

1. Function Introduction.....	4
2. Applications.....	4
3. Hardware Description	5
4. Accessories	6
5. Specifications.....	7
6. Operating Instructions.....	7
6.1 Terminal Installation.....	8
6.2 SIM CARD Installations	9
6.3 Turn on the Tracker Device.	9
6.4 GSM/GPS LED Indicator.....	10
6.5 Initialization.....	10
6.6 Change Password	10
6.7 Authorization.....	11
6.8 Single Locating.....	12
6.9 Auto track continuously	12
6.9.1 Track with limited times upon time interval:.....	12
6.9.2 Track with unlimited times upon time interval:.....	13
6.9.3 Smart track upon time and distance interval:.....	13
6.10 Automatic update positions of vehicle turns.....	14
6.11 GPS drift suppression	14
6.12 Absolute street address by SMS.....	14
6.13 Location based service (LBS).....	15
6.14 Monitor	15
6.15 Data logging.....	16
6.16 Data Load	17
6.17 Forward the third parties' message.....	17
6.18 Charges Inquiry.....	17
6.19. Alarms	18
6.19.1 Low battery alarm	18
6.19.2 Power off alarm.....	18
6.19.3. GPS blind Spot alert.....	18

6.19.4 SOS	18
6.19.5 Geo-fence	19
6.19.6 Multi-area management.....	19
6.19.7 Movement alarm	21
6.19.8 Over speed alarm	21
6.19.9 Accident alarm (Option):	22
6.19.10 ACC working alarm	22
6.19.11. Fuel alarm.....	23
6.20 Cut off the Oil and Power System.....	23
6.21 Arm.....	23
6.22 Disarm	24
6.23 Function of Remote Controller (Option, for model B ONLY)	25
6.24. Alarms under Arm State	25
6.24.1 Door alarm.....	25
6.24.2 Shock Sensor alarm	25
6.24.3 ACC alarm	25
6.25. Silent Mode	26
6.26. Alarm without GSM network service.....	26
6.27 Check the Vehicle State.....	27
6.28 Reset Hardware.....	27
6.29 Check IMEI.....	28
6.30 Terminal (local) Time Setting.....	28
6.31 TCP/UDP switch.....	28
6.32 Configure parameters by USB	28
6.33 GPRS Setting.....	29
6.34 Less GPRS traffic	30
6.35. Modes Switch between “SMS” and “GPRS”	31
6.36 Set up monitor center number	31
6.37 Web platform and PC installation tracking software user manual	31
7. Cautions	32

8. Faults & the Solutions	32
---------------------------------	----

1. Function Introduction

1.1 This tracker is a new product based on the GSM / GPRS network and GPS satellite positioning system, which set multiple functions of security, positioning, monitoring surveillance, emergency alarms and tracking in its entirety. It can track and monitor remote target by SMS or internet.

1.2 Features

1.2.1 Support both GPS & LBS (Location based service).

1.2.2 Support SMS/GPRS/Internet Network data transmission
(GPRS/Internet instructions includes in CD in package)

1.2.3 Support GPRS on-line and GPRS re-connected automatically if
GPRS drops

1.2.4 Support SMS / GPRS dual-mode switching

1.2.5 Support configuration by remote terminal.

1.2.6 Support for point-to-point, point to group, group-to-group
monitoring.

1.2.7 Set multiple functions of security, positioning, monitoring surveillance,
emergency alarms and tracking in its entirety.

2. Applications

Used widely for vehicle and other moving objects tracking.

3. Hardware Description

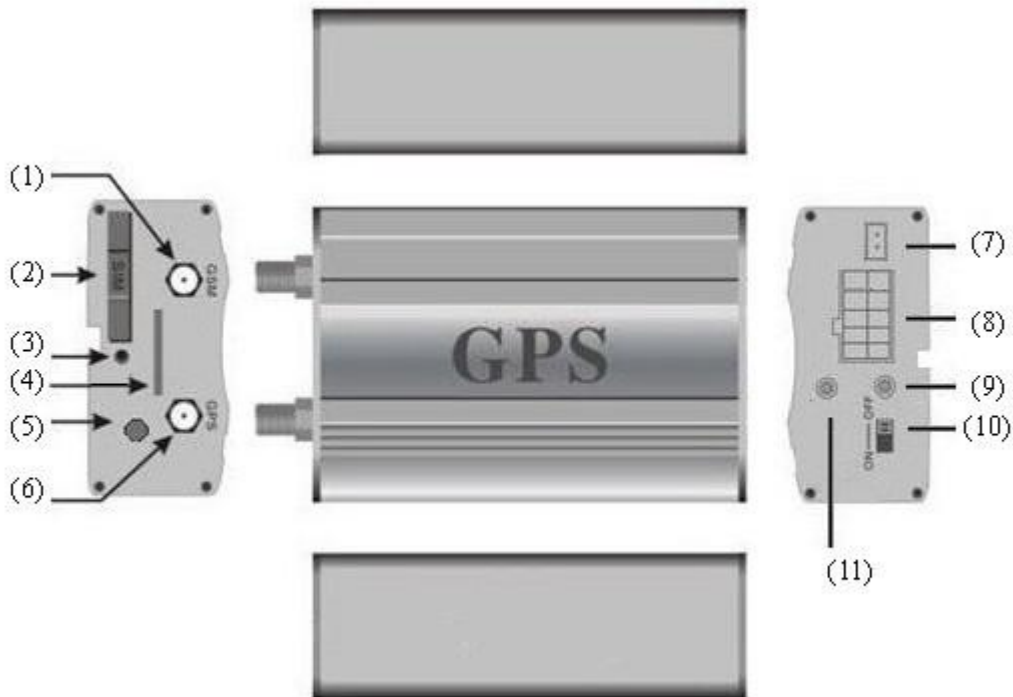

① GSM Antenna connector

② SIM card slot

③ SIM card slot Pop-up switch

④ MicroSD slot

⑤ Monitor microphone jack

⑥ GPS Antenna connector

⑦ Shock sensor port

⑧ Harness Port



⑨ GSM/GPS LED

⑩ Backup battery switch

⑪ Remote controller antenna

(Optional for Model B only)

4. Accessories

NO.	PHOTOES	NAME	NOTE
1		GPS Antenna	3 meters
2		GSM Antenna	3 meters
3		Microphone	1.5 meters
4		Harness	10PIN
5		Relay	12V/40A to 24V/40A according to vehicles
6		Shock sensor	Option for both model A and B
7		Siren	Option for both model A and B
8		Remote controller	Option for model B ONLY

5. Specifications

Content	specifications
DIM.	83*54*26mm
Weight	120g
Network	GSM/GPRS
Band	850/900/1800/1900Mhz
GPS Module	SIRF3 chip
GPS Sensitivity	-159dBm
GPS Accuracy	5m
GPS Start time	Cold status 45s Warm status 35s Hot status 1s
Voltage of car power system	12 V -24V
Backup battery	Chargeable 3.7V500mAh Li-ion battery
Storage Temp.	-40 °C to +85 °C
Operation Temp.	-20 °C to +65 °C
Humidity	5%--95% non-condensing

6. Operating Instructions

6.1 Terminal Installation

6.1.1 Please ask the qualified engineers to install it.

6.1.2 Do not install it in an environment which is over GSM performance index, and please pay attention to fix the antennas in an appropriate position with good signals.

6.1.3 Pay attention to make installation location preventing water and dust.

6.1.4 Find the 10 PIN harness and insert it into the corresponding holes of the products, and connect the wires with the original car circuit showing below:

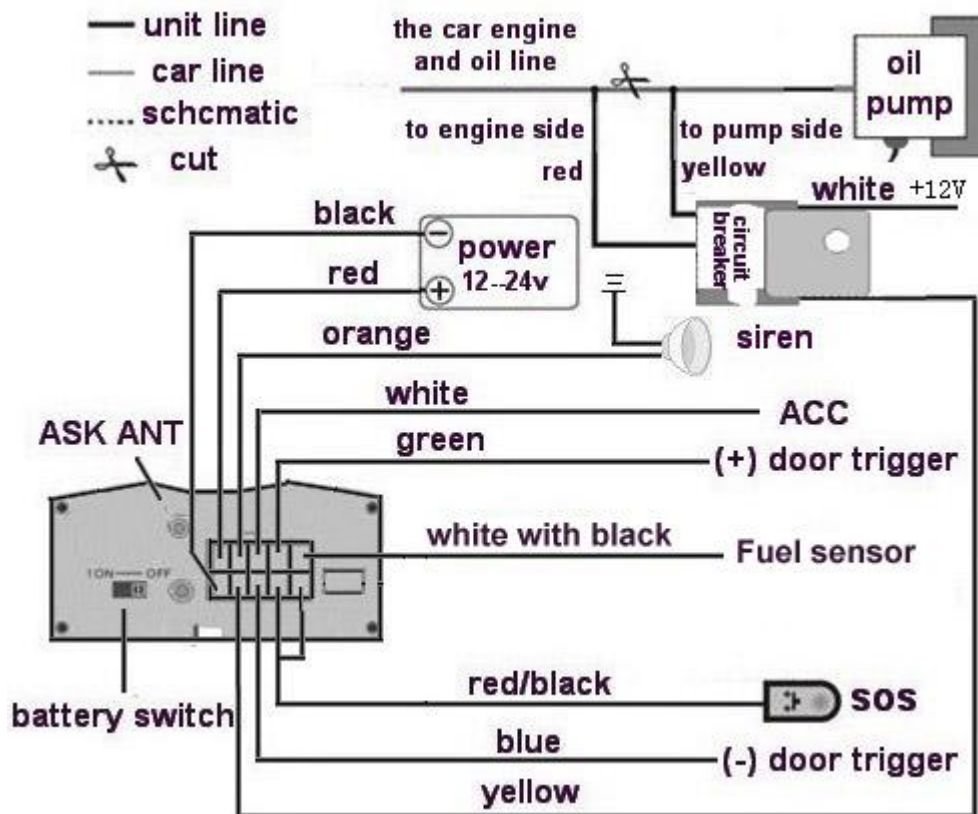

Wiring diagram

6.1.5 Note: The orange wire can be connected to the original car horn; it can also be connected to the siren you buy with the tracker. (Siren is

Option)

6.1.6 Knowing about the type of the door trigger is positive or negative trigger.

Please connect the green wire to the door control circuit if it is positive, and connect blue wire if it is negative.

6.1.7 Please install the Reset button and SOS button on the place driver can touch.

6.1.8 Insert the shock sensor plug into the sensor jack. (Shock sensor is Option)

6.1.9 Insert the external monitor Microphone into the monitor jack.

6.1.10 Connect the GPS and GSM antenna to the right connector, and find an appropriate place and fix the antennas to make sure it receive signals well.

6.2 SIM CARD Installations

6.2.1 Use a tweezers or a sharp thing to touch the SIM CARD popup switch, the SIM CARD slot will pop up, take out the SIM card slot and put SIM card in it. And then put the SIM card slot back to its original position after confirm the SIM card in the right place.

6.2.2 Please make sure the SIM card is for GSM network and able to execute the function of incoming calls display, no calls can be diverted and the PIN code is locked. The SMS format must be TXT format, and can't recognize the PDU format.

6.3 Turn on the Tracker Device.

6.3.1 Connect the positive and negative wire, red and black ones, with 12V or 24V car power system, wait for 1 minute after connecting power to wait

tracker works normal, and then turn on the backup battery switch.

6.4 GSM/GPS LED Indicator

6.4.1 Red LED indicator on: No GSM network signals.

6.4.2 Red LED indicator flashes fast (one time each second): GSM Network signal is normally, and tracker works under GSM mode.

6.4.3 Red LED indicator flashes slowly (one time each three second): Tracker works under GPRS mode.

6.4.4 Green LED indicator on: GPS signal is normal.

6.4.5 Green LED indicator off: No GPS signals.

6.5 Initialization

Send SMS “begin+password” to the unit, it will reply “begin ok” and initialize all the settings to default factory settings. (default password: 123456)

For example: send SMS “begin123456”, it will reply “begin ok”. (No quotation marks“” when sending all the SMS)

6.6 Change Password

6.6.1 Send SMS “ password+old password+space+new password” to the unit to change the password.

For example: send SMS “password123456 888888” to the unit. If succeeded, “password ok” will reply to your cell phone from the device

tracker.

6.6.2 Be sure to keep the new password in mind, you have to upload the software to restore the original setting in case of losing the new password.

6.6.3 Attention: Make sure the new password is in 6 digits Arabic numbers, or else the tracker cannot recognize the password.

6.6.4 **The “+” in the command, please don’t type “+”, space means press the space keyboard on your cell phone.**

6.7 Authorization

There are 5 numbers to be allowed to authorize in the tracker at most.

6.7.1 Call and track the tracker device for 10 times from cell phone in success, it will make the cell phone number as the authorized number automatically, and reply “add master ok”.

6.7.2 Authorization: Send SMS “admin+password+space+cell phone number” to set up an authorized number, the other authorized numbers should be set by the first authorized number, if the number is successfully authorized, the unit will reply “ admin OK” by SMS.

6.7.3 Delete authorization: Send SMS “noadmin+password+space+authorized number” to delete the authorized number.

6.7.4 If you want to track the target tracker device when it enters into another country, you must add the country code before the cell phone number, for example, send SMS “admin123456 008613322221111” to the device.

Note: 13322221111 will be set up as the authorized number.

6.8 Single Locating

6.8.1 Any number call the tracker device, it will reply a SMS including the position of latitude and longitude if don't set up the authorized number. If authorized number has set successfully, the device won't reply SMS including the positioning of latitude and longitude when the unauthorized number dials up it.

6.8.2 Dialing the tracker device from the authorized number, it will hang up your calling and respond to a real-time latitude and longitude information as following:



Tracking location, when no GPS signal, the SMS includes the last valid latitude & longitude as well as the LAC code of current position, the LAC code can be input in the column of “manual track” menu of web platform to check location.

6.9 Auto track continuously

6.9.1 Track with limited times upon time interval:

Send SMS command “fix030s005n +password” to the tracker device, it will report the latitude & longitude at intervals of 30 seconds for 5 times. (s:second, m:minute, h:hour). This command set must be in 3 digits and the maximum value is 255.

6.9.2 Track with unlimited times upon time interval:

Send SMS “fix030s***n+password” to the tracker device, it will reply the latitude & longitude continuously at interval of 30 seconds.

Note: the interval must not less than 20s.

6.9.3 Smart track upon time and distance interval:

6.9.3.1 Please set "track with unlimited times upon time interval" before this function, and send "distance+password+space+distance", tracker will reply "Distance ok", and then tracker will locate upon both the pre-set time and distance.

E.G: Send "distance123456 0050", it means distance is 50 meters; the number must be 4 digits Arabic numbers.

6.9.3.2 Set this function on web server: Set time interval first and then distance interval, tracker will locate upon the time and distance.

6.9.4 Cancel: Send SMS “nofix+password” to the tracker device to cancel the “auto track”.

6.10 Automatic update positions of vehicle turns

6.10.1 The tracker will update the positions automatically to web server once the vehicle changing driving direction over pre set angle value to form a smooth trajectory consistent with the actual road, this function is only effective in GPRS mode.

6.10.2 Send "angle+password+space+angle" to tracker, it will reply" angle ok".

6.10.3 The angle must be 3 digits Arabic numbers, default angle value is 30 degree.

6.11 GPS drift suppression

6.11.1 This function is deactivated as default, send "suppress+password" to tracker, it will reply" suppress drift ok". The GPS data stop updating if vehicle is not driving (ACC is OFF) and latitude and longitude always keep same, and GPS data updates automatically when vehicle is moving.

6.11.2 Cancel: send "nosuppress+password" to tracker, it will reply" nosuppress ok ".

6.12 Absolute street address by SMS

6.12.1 You must set up the APN of your local GSM network for the SIM card in tracker first before using this function, if there is user name and password for GPRS login, Please refer to 6.33.1 and 6.33.2 to configure the APN, user name and password for GPRS login.

6.12.2 After configure the APN, send "address+password" to device, it will reply SMS including real street/address name. For example: No.113,

Guankou 2nd Rd, Nantou, Nanshan district, Shenzhen, Guangdong, china.

6.13 Location based service (LBS)

When the tracker device doesn't received valid GPS signals, tracker will positioning by location based service(LBS), the messages includes the GPS coordinates of the last position in SMS mode, but the LAC in message is the current new position, the location can be seen by input the LAC code in the menu "Manual Track" of web platform www.gpstrackerxy.com, you can also send command "address+password" to tracker to get the newest absolute address and GPS coordinates as well; tracker will automatically switch to track by location based service in GPRS mode, and actualized on the map of web server with LBS mark. And there may be some inaccuracy with actual location by LBS tracking; the bias depends on GSM reception.

Note: This feature can be used normally in most areas according to the signal of GSM network. It may not be available in some areas.

6.14 Monitor

6.14.1 The command to switch between Track and Monitor are "tracker" and "monitor".

6.14.2 The default mode is "track" (Track mode).

6.14.3 Send SMS "monitor+password" to the unit, and it will reply "monitor ok!" and switch to "monitor" mode.

6.14.4 Send SMS “tracker+password” to the unit, it will reply “tracker ok!” and restore to “track” mode.

6.15 Data logging

6.15.1 Auto logging: When the tracker device lost GSM signals or fall offline from GPRS, tracker will log the tracking position and alerts automatically in the SD card on the basis of the pre-set condition, when GSM signals get back, all the event alerts will be auto-sent to the authorized numbers or monitoring platform (server), but the logged tracking data should be loaded to the monitoring platform via SMS command.

6.15.2 Logging upon times: Send SMS: “save030s005n+password” to the tracker unit, it will reply “save ok”, and will log the lat, long locations every 30 seconds for 5 times. (S: second, m: minute; h: hour).

6.15.3 Multi-logging: Send SMS:”save030s***n+password” to tracker device, it will reply “save ok”.

6.15.4 Logging Clearance: send SMS: “clear+password” to tracker device, it will reply “clear ok”.

6.15.5 Logging Volume: It depends on the capacity of the SD card inserted in the tracker device.

6.15.6 The logged data in SD card can be copied to computers through card reader, and then the data route can be checked by importing data in the menu “Data Import” of web platform www.gpstrackerxy.com

6.16 Data Load

6.16.1 Current date Load: Send SMS: “load+ password” to tracker device, it will reply: “load ok” if the device is working well under GPRS mode; if not, it will reply “load fail! Please check gprs” that means device does not work under GPRS mode.

6.16.2 Specified date Load: Send SMS: “load+ password+ space+ year month date” to tracker device, it will reply: “load ok” and load the tracking data to the monitoring platform upon the valid time you choose. For Example: send SMS: “load123456 20110425” to the tracker device, means to load the tracking data of 25th April 2011 to monitoring platform.

6.17 Forward the third parties’ message

6.17.1 Send SMS "forward+password+space+third parties phone number" from authorized phone number, tracker will reply"forward ok", and supports 1 third parties phone numbers at most.

For example, set the phone number of the service provider of the simcard in the tracker, when charge remind message coming in, tracker will forward it to authorized phone number.

6.17.2 Cancel: Send SMS command "noforward+password".

6.18 Charges Inquiry

Send SMS command "balance+password+space+carrier’s phone

number+space+code" to tracker, it will forward the code to carrier's phone number and return the balance message received from carrier's phone number.

6.19. Alarms

6.19.1 Low battery alarm

6.19.1.1 Send SMS "lowbattery+password+space+on", it will send SMS "lowbattery+latitude/longitude" to authorized numbers 2 times in total in 15 minutes interval when voltage of battery is going to be about 3.55V.

6.19.1.2 This function activates as default, send SMS "lowbattery+password+space+off" to deactivate.

6.19.2 Power off alarm

6.19.2.1 Send "extpower+password+space+on" to activate, it will send SMS "power alarm+latitude/longitude" to authorized numbers every 3 minutes when external power is cut off.

6.19.2.2 This function activates as default.

Cancel: Send SMS "extpower+password+space+off" to deactivate it.

6.19.3. GPS blind Spot alert

6.19.3.1 This function deactivates as default, send SMS "gpssignal+password+space+on", it will send alert SMS "no gps+last valid latitude/longitude before lost signal"

6.19.3.2 Send SMS "gpssignal+password+space+off" to deactivate.

6.19.4 SOS

Long Press the SOS button for 3 seconds (For model B, press  button on remote controller for 3 seconds), the tracker device will send SMS "help

me!+lat./long.” to all the authorized numbers at interval of 3 minutes. It will stop sending such a SMS when any authorized number reply SMS “help me!” to the tracker.

6.19.5 Geo-fence

Set up a geo-fence for the tracker device to restrict its movements within a district. The unit will send SMS to the authorized numbers when it goes out of this district.

Set up: When the unit stays immobile in a place for 3-10 minutes, the user can send

SMS “stockade+password+space+latitude,longitude;latitude,longitude” to

unit to set the restricted district. In case of breach, it will send SMS

“stockade!+ latitude & longitude” to the authorized numbers at interval of 3 minutes.

Remark: The first latitude & longitude is coordinate of the top left corner of the Geo-fence, while the second latitude & longitude is the coordinate of the bottom right corner, it will alarm at interval of 3 minutes.

Cancel: Send SMS “nostockade+password” to deactivate this function.

6.19.6 Multi-area management

6.19.6.1 Set Area

Send SMS command

"area+password+space+latitude,longitude+space+areaname,distanceM" to tracker(distance unit: M for meter, K for kilometer), it will reply "area01 ok".

Example: Send "area123456 22.353648,113.543678 school,800M".

Note: 5 areas at most and the distance between two points can't be less than the total distance in the 2 commands, and different areas can't cover each other.

6.19.6.2 Delete areas

Send SMS command:"noarea+password+space+area name", tracker will reply:"noarea ok".

6.19.6.3 Rename and set distance

Send SMS command "rename+password+space+old name;new name,distanceM" to tracker, if name is not repeated and area doesn't cover others, it will reply "rename ok!" for successful configuration.

Example: Send"rename123456 area01;school,800M", it means the new area name is "school", and covers area of a radius of 800 meters.

6.19.6.4 Activate multi-area management

Send SMS command "area+password+space+on" to tracker, it will reply "Area on ok!", when tracker enter the pre set area, it will send SMS "area name+latitude & longitude" to all the authorized phone number, and send same SMS when goes out of the area.

6.19.6.5 Deactivate Multi-area management

Send SMS command "area+password+space+off" to tracker, it will reply "area off ok!"

6.19.7 Movement alarm

6.19.7.1 Set up: when the unit stays immobile in a place for 3-10 minutes with

GPS signal reception, the user can send

SMS "move+password+space+0200" to the tracker (Suppose area of a radius of 200 meters, it supports 4 digits at most. Unit: Meter). It will reply "move OK". In case of such a movement (the default distance is 200m), it will send SMS "Move+ latitude & longitude" to the authorized numbers at interval of 3 minutes.

6.19.7.2 Cancel: Send SMS "nomove+password" to deactivate the movement alarm.

6.19.8 Over speed alarm

Set up: Send SMS "speed+password+space+080" to the unit (suppose the

speed is 80km/h), and it will reply “speed OK!”. When the target moves exceeding 80km/h, the unit will send SMS “speed+080!+ latitude & longitude” to the authorized numbers at interval of 3 minutes.

Cancel: Send SMS “nospeed+password” to deactivate the overspeed alarm.

Remark: The recommended speed should be not less than 30km/h. For below that rate, it will be effected the accuracy by GPS signals drift etc.

6.19.9 Accident alarm (Option):

When tracker detects accident occurred (severe impact), it will send " Accident! + latitude & longitude " to all authorized phone numbers.

6.19.10 ACC working alarm

6.19.10.1 This function is disabled as default. To active this functions, send "ACC+password" to tracker, it will reply "ACC ok". And tracker will send "ACC on+latitude & longitude" to authorized numbers when detect ignition action, that means the vehicle has been started; and tracker will send “ACC off+latitude & longitude" to authorized numbers, that means ACC off.

6.19.10.2 Send "noACC+password" to disabled this function, tracker will reply "noACC ok".

6.19.10.3 This configuration can only enable and disable the alarm to authorized

numbers; it will send to web server automatically in GPRS mode and can't be disabled.

6.19.11. Fuel alarm

6.19.11.1 When the fuel consumption exceeds the normal standards during driving, or oil theft/leakage when the vehicle is stopped, the tracker will send "oil: xx% + Geo-info" to the authorized number at interval of 3 minutes. The horn beeps 30S.

6.19.11.2 Cancel: Send SMS command “nooil+password” to tracker.

6.19.11.3 Tracker supports two fuel sensors.

6.20 Cut off the Oil and Power System

6.20.1 Send command “stop+password” to tracker, tracker will execute it and reply “Stop engine Succeed”. And it will remain immobile state until next command to resume.

6.20.2 Stop mode

6.20.2.1 Execute immediately: Send command “quickstop+password” to tracker, it will reply “quickstop OK”. Then tracker will stop the car immediately after “stop” command.

6.20.2.2 Execute depends on speed(Default mode): Send command “noquickstop+password” to tracker, It will reply “noquickstop OK”, Then the tracker won't stop the car immediately after “stop” command, instead, it will reply “it will be executed after speed less than 20KM/H”, and stop the car when the speed is less than 20KM/H.

6.20.3 Resume the Oil and Power System

Send “resume+password” to tracker, it will reply "Resume engine succeed", that means vehicle has resume the oil supply.

6.21 Arm

6.21.1 Set up arm by SMS

Send SMS command “arm+password” to the tracker device in the vehicle. It

will reply “Tracker is activated” in both armed and disarmed state, and the SMS command will make the tracker device enter into armed state if the unit currently disarmed.

User must stop the engine, (that is ACC is lower voltage). Sending SMS “arm+password” when close the door and left. You will set up arm status fail if the engine is turned on (the ACC is high voltage), it will reply “set up fail! pls turn off ACC”

6.21.2 Set up arm by remote controller (Option, for model B ONLY)

Press  button on the remote controller for 0.5 seconds, the car enters into armed state and the siren will beep one time, no SMS reply.

6.22 Disarm

6.22.1 Disarm by SMS







Send SMS command "disarm + password" to the tracker device in the vehicle, It will reply “Tracker is deactivated” in both armed and disarmed state, and the SMS command will make the tracker device enter into disarmed state if the unit currently armed.

It won't alarm if the door is open and sensor is vibrated and the engine is started when deactivated this arm function.

6.22.2 Disarm by remote controller (Option, for model B ONLY)

Press  button on the remote controller, the car enters into disarm state, and the siren will beep two times, no SMS reply.

6.23 Function of Remote Controller (Option, for model B ONLY)

Button	Function	Descriptions
	ARM	Press for 0.5 second, the siren will beep one time.
	DISARM	Press for 0.5 second, the siren will beep two times.
	ARM & Silent mode	Press for 0.5 second when it is in disarm state, the siren will beep three times. No voice from siren when alarm triggered and quit from siren mode automatically when disarm.
	SOS	Press for 3 seconds, Tracker will send SOS alert to authorized phone numbers without voice.
	Deterrence/car search	Press for 0.5 second when it is in arm state, siren will beep 10 seconds, press disarm button  to quit.

6.24. Alarms under Arm State

6.24.1 Door alarm

The unit will send SMS “Door alarm+lat/long” to the authorized number at interval of 3 minutes when the door of the car opens in arm status; Siren will be sound for 30 seconds, and repeat again after stop 1 minute, send “disarm+password” to stop it.

6.24.2 Shock Sensor alarm

The unit will send SMS “Sensor alarm+lat/long” to the authorized number at interval of 3 minutes when the sensor is triggered in arm status; Siren will be sound for 30 seconds, and repeat again after stop 1 minute, send “disarm+password” to stop it.

6.24.3 ACC alarm

The unit will send SMS “ACC alarm+lat/long” to the authorized number in an interval of 3 minutes when the engine of the car is turned on, that is the key is rotated to ACC.ON position to start the car in arm state; Siren will be sound for 30 seconds, and repeat again after stop 1 minute, send “disarm+password” to stop it.

6.25. Silent Mode

6.25.1 Set up silent mode by SMS

Send SMS “silent+password” to tracker device, it will reply “silent ok!”. It means tracker device enters into **silent mode**, siren won't be sound after alarm is triggered, but tracker will send alarm SMS to authorized number.

Quit silent mode send disarm command “disarm+password” .

6.25.2 Set up silent mode by remote controller (Option, for model B ONLY)

Silent mode Press  in disarm state for 0.5 second, the siren will beep one time, It means tracker device enters into **silent mode**, siren won't be sound after alarm is triggered, but tracker will send alarm SMS to authorized numbers.

Quit silent mode Press  to quit

6.26. Alarm without GSM network service

When the car is in the place without GSM network service, siren will be

sound under non-silent mode if alarm is triggered (door, sensor, ACC), but no SMS alarm will send to authorized number.

6.27 Check the Vehicle State.

Send SMS command “check+password” to the tracker device in the vehicle, It will reply the status of the power, battery, GPS, ACC, door, GSM signal to the authorized numbers. For example: Send SMS “check123456” to the tracker device in the vehicle, It will reply following SMS.

Power: ON/OFF

Battery: 100%

GPRS: ON/OFF

GPS: OK/NO GPS

ACC: OFF/ON

Door: OFF/ON

GSM Signal: 1-32(performance). Note: The higher digit it shows; the stronger of GSM signals it receives.

6.28 Reset Hardware

6.28.1 SMS Reset

Send SMS “reset+password” to tracker device to reset the GSM module and GPS module of the tracker device, it will reply “reset ok”.

6.28.2 Reset Button to Reset

Press the reset button for 1 second, hardware of tracker device will reset.

6.29 Check IMEI

Send SMS command "imei+password" to the unit. E.g. Send SMS command "imei123456" to the tracker device, an IMEI number in 15 digits will reply to your cell phone.

6.30 Terminal (local) Time Setting

6.30.1 Send SMS command "time+space+zone+password+space+time" to the tracker unit, If succeed, It will reply "time OK"

6.30.2 For example: Send SMS "time zone123456 8", 8 is Chinese time zone, If your country time zone is minus, send SMS "time zone123456 -8".

6.31 TCP/UDP switch

Command:"gprs+password,1,1" switch to UDP mode.

Command: "gprs+password,0,0" switch back to TCP mode, this is the default mode.

6.32 Configure parameters by USB

Copy the Serial debugging tool to computer, connect the tracker with computer and open Serial debugging tool with the USB cable (option), then choose correct COM port, baud rate is 19200, send serial port command (Tick "send new " on SSCOM interface): \$SET GT PARA, tracker will return the sample format of the command, send appropriate commands according to the sample format of command. Tracker will return "ok" after succeed in configuring to indicate successful configuration. **For detailed operations, please check "COM**

PORT COMMAND USER MANUAL”

6.33 GPRS Setting

User must send SMS via cell phone to set up APN, IP and port before starting tracking by GPRS.

6.33.1 Configure APN

6.33.1.1 APN standards for Access Point Name and differs from country to country. For more information about your local APN, please inquire with your local GPRS network operator.

6.33.1.2 Text the tracker a SMS “APN+password + Space + your local APN” via a cell phone and if succeeded, the tracker will return the message “APN OK”.

6.33.1.3 E.g. Send SMS command “APN123456 CMNET”. If succeeded, “APN OK” is returned by the tracker in SMS.

Notes: 123456 refer to password of tracker and CMNET is the APN of one of china GPRS Network Operator (China mobile).

6.33.2 GPRS User Name and password Setup

6.33.2.1 In most countries, the user name and password involving GPRS login are not compulsorily necessary, therefore, the entry can be skipped. For those countries requiring user name and password, please configure as

following:

6.33.2.2 Send SMS “up+password+space+user+space+password” If succeeded, “user, password ok!” is returned by the tracker in SMS.

6.33.2.3 For instance, send SMS “up123456 jonnes 666666” to the tracker, and if succeeded, the tracker returns “user, password OK”

Note: 123456 is tracker device password, jonnes is the user name for GPRS login, 666666 is the password for GPRS login.

6.33.3 IP and Port Setup

6.33.3.1. Send SMS as below via a cell phone:

adminip+password+Space+IPAddress+Space+Port Number. If succeeded, “adminip OK” is returned by the device in SMS.

6.33.3.2 E.g. Send SMS command “adminip123456 202.104.150.75 9000” to the tracker device, If succeeded, “adminip OK” is returned by the device in SMS. (123456 is default password, 202.104.150.75 is IP, 9000 is port).

6.34 Less GPRS traffic

6.34.1 Tracker will change to less GPRS traffic mode after parking 5 minutes (ACC is OFF), GPRS disconnect and connect again when alarm being triggered or vehicle starts driving.

6.34.2 Activate this function: Send "less gprs123456 on", tracker will reply "less gprs on ok".

6.34.3 Deactivate this function: Send "less gprs123456 off", tracker will reply "less gprs off ok".

Note: 123456 is the password of tracker, and replace it with the new if you have changed.

6.35. Modes Switch between “SMS” and “GPRS”

6.35.1 The default mode is “SMS”

6.35.2 Send SMS “GPRS+password” to the unit, and it will reply “GPRS ok!” it means tracker device has switched to “GPRS” mode.

6.35.3 Send SMS “SMS+password” to the unit, it will reply “SMS ok!” and restore to “SMS” mode.

6.36 **Set up monitor center number**

6.36.1 Setup: send command “centernum+password+space+number” to tracker, it will reply “centernum ok”. After setup monitor center number, the messages of auto track by sms will be set to this center number, if all alarms need to be sent to this number too, then this center number must be setup as authorized number.

6.36.2 Cancel: Send “nocenternum+password” to tracker, it will reply “no center num ok”.

6.37 Web platform and PC installation tracking software user manual

6.37.1 Web based platform www.gpstrackerxy.com. Configuration IP: 202.104.150.75 Port: 9000. Please check “software platform user manual” included in the CD for detailed operation information.

6.37.2 PC based installation tracking software user manual included in the CD in package.

7. Cautions

Please comply with the instructions to extend the unit life:

1. Keep the unit dry. Any liquid, i.e. rain, moisture, may destroy or damage the inside circuitry.
2. Don't use & store the unit in dusty places.
3. Don't put the unit in overheated or overcooled places.
4. Handle carefully. Don't vibrate or shake it violently.
5. Clear the unit with a piece of dry cloth. Don't clean in chemicals, detergent.
6. Don't paint the unit, this may cause some foreign materials left in between the parts.
7. Don't disassemble or refit the unit.
8. Please read the user manual carefully before installation and operation, learn something more about the voltage range. Otherwise, it won't work properly or destroy the product.

8. Faults & the Solutions

Faults	Solution
Startup Fail	Please check out the power wiring in correct place.

Call Fail	Check the GSM antenna connected. Check whether the SIM card in place. Check whether the normal power supply voltage.
Hang up Fail	In existence of an authorized number, an unauthorized number dials up the unit. Please initialize the unit and re-set up the authorized numbers.
Monitor Fail	Check if the authorized number is setup
Location report in digits of zeros.	Check out if the GPS external antenna well.